

Article number: 2301072772

Description: E+G Handwheel  
VDS.150+IRS-A16

## Measures

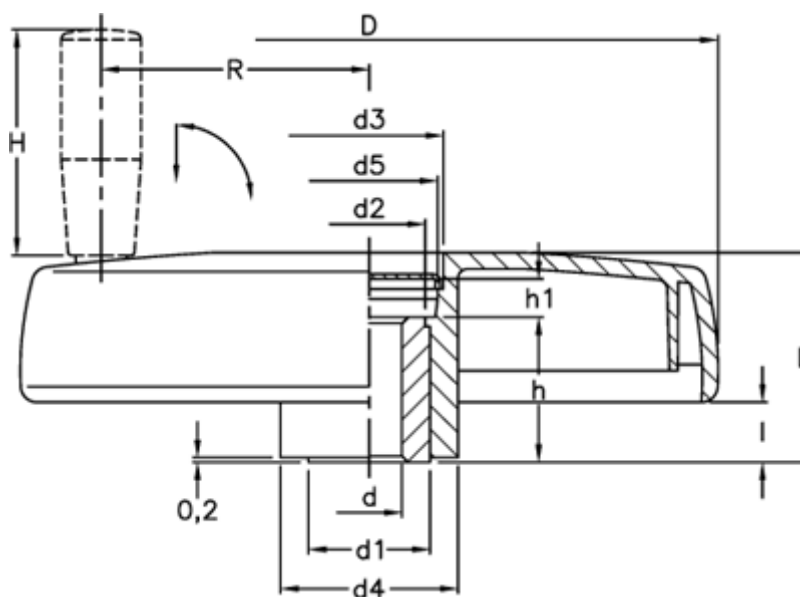

C (N m) = 180	H = 65
D = 150	h = 30
d1 = 26	h1 = 10
d2 = 24.0	l = 12
d3 = 34.0	L = 44
d4 = 38	L (J) = 15
d5 = 30	R = 58
d H7 = 16	